

CAT. No.

74901

UNIVERSAL MULTI-CONFIGURATION 20 AMPERE 250 VOLT EUROPEAN, UK, BRITISH, DENMARK, SWISS, AUSTRALIA, CHINA, JAPAN, BRAZIL, ARGENTINA, AMERICA (NEMA), SOUTH AMERICA, ASIA, THAILAND, ISRAEL, INTERNATIONAL POWER OUTLET, 36mmX36mm SIZE, SHUTTERED CONTACTS, 2 POLE-3 WIRE GROUNDING (2P+E). IVORY.

CERTIFICATIONS

REACH  ROHS  ROHS3  CE

STANDARDS

UNIVERSAL  EUROPEAN  INTERNATIONAL  NEMA

PAGE 1 OF 4

**NOTE:**

1. MOUNTS ON AMERICAN 2X4, 4X4 WALL BOXES OR PANEL MOUNT. SURFACE MOUNTS ON WALL BOXES #74225, #84225-AR.
2. MOUNTS IN "12", "3", "6", "9" CLOCK HOUR POSITIONS ON WALL PLATES/MOUNTING FRAMES.
3. PLUG ADAPTERS #30140-A, 30140-BLK, 30140-RHD, 74901-SGA AVAILABLE. ADAPTERS PROVIDE "EARTH" GROUNDING CONNECTION FOR EUROPEAN CEE 7/7, CEE 7/4 "SCHUKO" PLUGS.

ALL DIMENSIONS ARE IN MILLIMETERS

**RELATED PRODUCTS:**

CATALOG No.

DESCRIPTION

74970-W	PANEL MOUNT FRAME (SNAP-IN), 1 OUTLET, IVORY
74930	PANEL MOUNT FRAME (SCREW MOUNT), 1 OUTLET, IVORY
74940	PANEL MOUNT FRAME (SCREW MOUNT), 2 OUTLETS, IVORY
74950	SURFACE MOUNT FRAME (SCREW MOUNT), 1 OUTLET, IVORY
74960	SURFACE MOUNT FRAME (SCREW MOUNT), 2 OUTLETS, IVORY
74910	WALL BOX (2x4) MOUNT, 1 OUTLET, IVORY
74920	WALL BOX (2x4) MOUNT, 2 OUTLETS, IVORY
74925	WALL BOX (4x4) MOUNT, 4 OUTLETS, IVORY
58206	POWER STRIP, 6 OUTLETS, IVORY
58206-C14	POWER STRIP, 6 OUTLETS, C-14 INLET, IVORY
58206-C14-USB	POWER STRIP, 4 OUTLETS, 2 USB, C-14 INLET, IVORY
58205	POWER STRIP, 5 OUTLETS, IVORY
58205-C14	POWER STRIP, 5 OUTLETS, C-14 INLET, IVORY
58204-C14	POWER STRIP, 4 OUTLETS, C-14 INLET, BLACK
58208-C14	POWER STRIP, 8 OUTLETS, C-14 INLET, BLACK

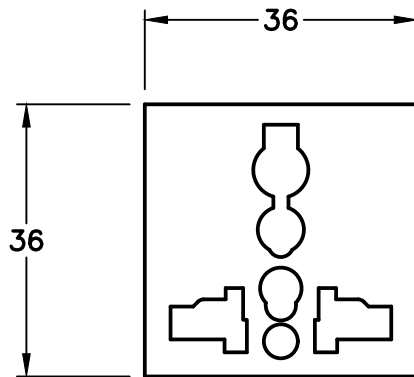

FRONT VIEW

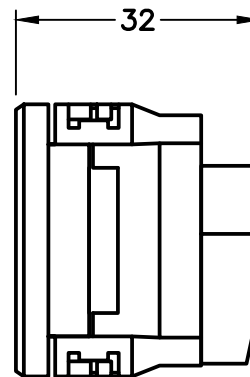

SIDE VIEW

POWER STRIP OUTLETS (SOCKETS) ACCEPT MALE PLUG TYPES NOTED BELOW

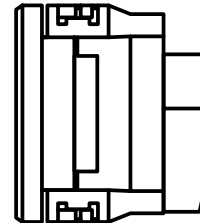
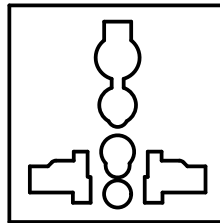











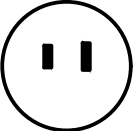
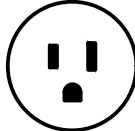
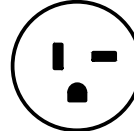
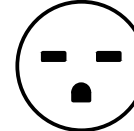
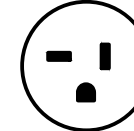
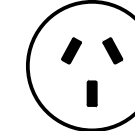
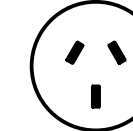
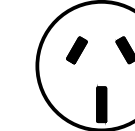



**IMPORTANT:**

THE "MAXIMUM" RATING OF 74901 IS 20 AMPERE 250 VOLT.

\*POWER STRIP DOES NOT PROVIDE GROUNDED CONNECTION WHEN EU1-16P AND FR1-16P 3-WIRE GROUNDING PLUGS ARE USED.

USE 74900-SGA (SEE PAGE 3) OR 30140-BLK (SEE PAGE 4) TO ACHIEVE GROUNDED CONNECTION.

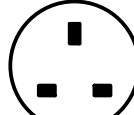
**PLUG TYPES**

 NEMA 1-15P / 15A-125V	 NEMA 5-15P / 15A-125V	 NEMA 5-20P / 20A-125V	 NEMA 6-15P / 15A-250V	 NEMA 6-20P / 20A-250V	 AR1-10P / 10A-250V	 AU1-10P / 10A-250V	 AU2-15P / 15A-250V	
 BR2-10P / 10A-250V	 BR3-10P / 20A-250V	 CH1-10P / 10A-250V	 DE1-13P / 16A-250V	 *EU1-16P / 16A-250V	 EUROPLUG / 4.0 MM PINS	 IS1-16P / 16A-250V	 IT1-10P / 10A-250V	
 SA1-16P / 16A-250V	 SW1-10P / 10A-250V	 TH1-16P / 16A-250V	 UK1-13P / 13A-250V	 UK3-5P / 5/6A-250V	<p><b>CONFIGURATION IDENTIFICATIONS</b></p> <p>AR = ARGENTINA                      AU = AUSTRALIA/NEW ZEALAND                      CH = CHINA                      DE = DENMARK                      EU = EUROPEAN "SCHUKO"/GERMANY                      EU/FR = FRANCE                      IS = ISRAEL                      IT = ITALY/CHILE</p>		<p><b>CONFIGURATION IDENTIFICATIONS</b></p> <p>NEMA = USA/CANADA/MEXICO                      SA = SOUTH AFRICA                      SW = SWITZERLAND                      TH = THAILAND                      UK = HONG KONG                      UK = SAUDI ARABIA/GULF STATES                      UK = S. AFRICA/INDIA                      UK = UNITED KINGDOM/IRELAND</p>	

CAT. No.

74900-SGA

ADD-ON ADAPTER FOR EUROPEAN, GERMAN, FRENCH CEE 7/7, 7/4 SCHUKO 16 AMPERE 250 VOLT PLUGS WHEN PLUGS ARE MATED WITH "UNIVERSAL" MULTI-CONFIGURATION POWER STRIPS, SOCKETS. ADD-ON ADAPTER PROVIDES "EARTH" GROUNDING CONNECTION.

**NOTE:**

- 1) CAUTION: FOR INSTALLATION AND USE BY QUALIFIED PERSONNEL ONLY.
- 2) INSTALL ADAPTER ON SCHUKO PLUG FIRST. ALIGN AND INSERT PLUG ADAPTER "GROUNDING EARTH PIN" INTO THE UNIVERSAL RECEPTACLE "GROUNDING" EARTH CONTACT ONLY AS INDICATED BELOW, STEPS 1, 2, 3.
- 3) SECONDARY OPTION: USE ADAPTER #30140-BLK IN PLACE OF 74900-SGA

PAGE 3 OF 4

ALL DIMENSIONS ARE IN MILLIMETERS

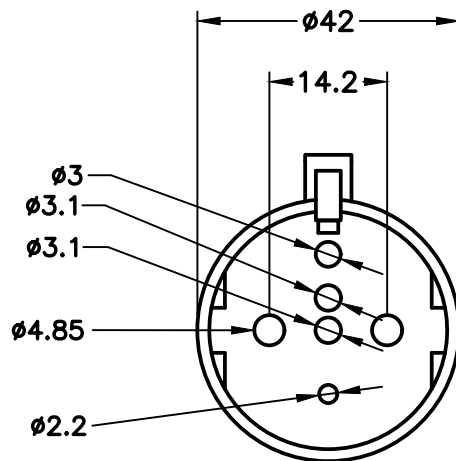
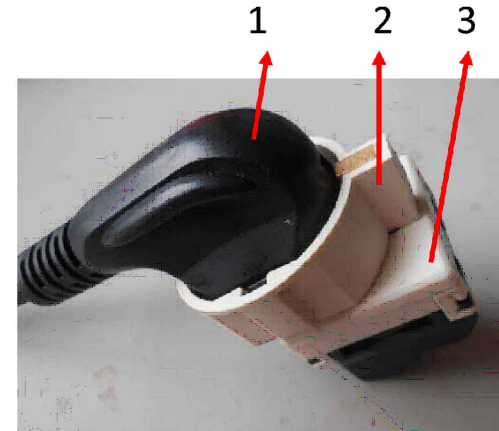
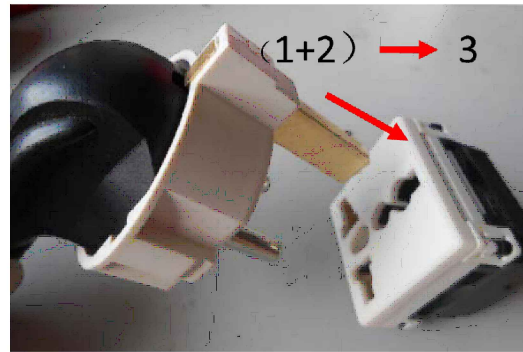
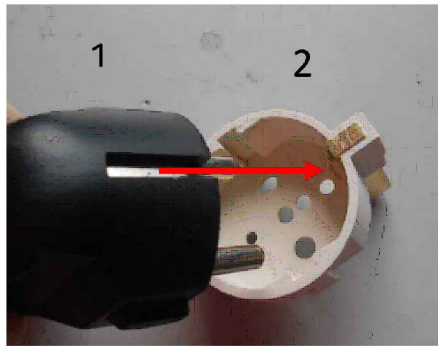

FRONT VIEW

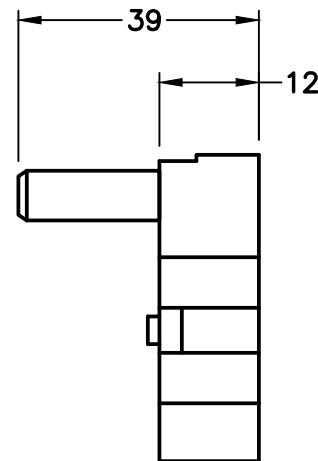

SIDE VIEW

CAT. No.

30140-BLK

BRITISH, UNITED KINGDOM 13 AMPERE 250 VOLT TYPE G PLUG ADAPTER. MATES SCHUKO, GERMAN, FRENCH, EUROPEAN CEE, CEE 7/4, CEE 7/7, CEE 7/16 (EU1-16P) PLUGS TO BRITISH BS 1363A (UK1-13R) POWER OUTLETS, 2 POLE-3 WIRE GROUNDING (2P+E), 13 AMPERE BS 1362 FUSE. BLACK.

CERTIFICATIONS

CE

STANDARDS

CEE 7/7  CEE 7/16  CEE 7/17  BS 1363A  BS 1363  BS 1362  DIN 49440/49441

PAGE 4 OF 4

ALL DIMENSIONS ARE IN MILLIMETERS

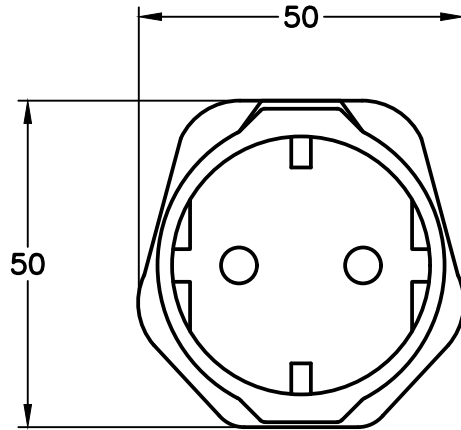

EU1-16P  
FRONT VIEW

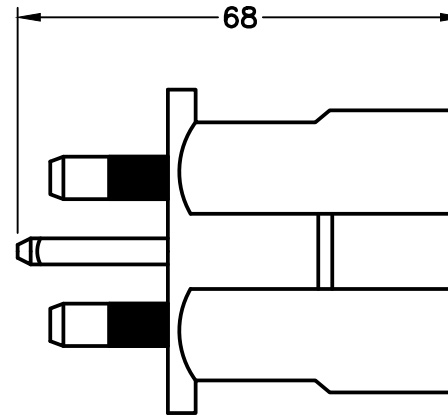

TOP VIEW

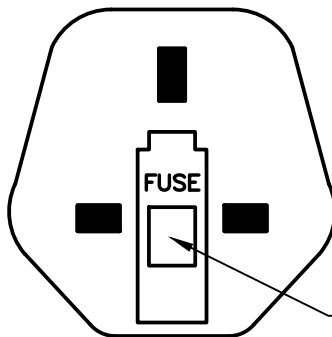

UK1-13P  
BACK VIEW

CHANGEABLE  
13 AMP FUSE

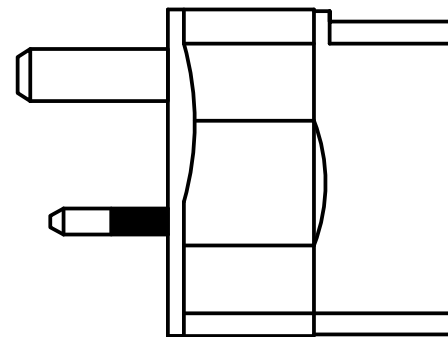

SIDE VIEW