

CAT. No.

73556-UV-B

UNIVERSAL 20 AMPERE 250 VOLT EUROPEAN, UK, BRITISH, DENMARK, SWISS, AUSTRALIA, CHINA, JAPAN, BRAZIL, ARGENTINA, AMERICA NEMA, SOUTH AMERICA, ASIA, THAILAND, ISRAEL, INTERNATIONAL, MULTI-CONFIGURATION DUPLEX OUTLET, BS 1363 TYPE G (UK1-13R), 86mmX146mm SIZE, SHUTTERED CONTACTS, 2 POLE-3 WIRE GROUNDING (2P+E). BLACK.

CERTIFICATIONS

ROHS CE

STANDARDS

EUROPEAN INTERNATIONAL TIS 166-2549

PAGE 1 OF 4

NOTES: OUTLET MOUNTS ON EUROPEAN, BRITISH WALL BOXES WITH 120mm (120.6mm) CENTERS.

ALL DIMENSIONS ARE IN MILLIMETERS

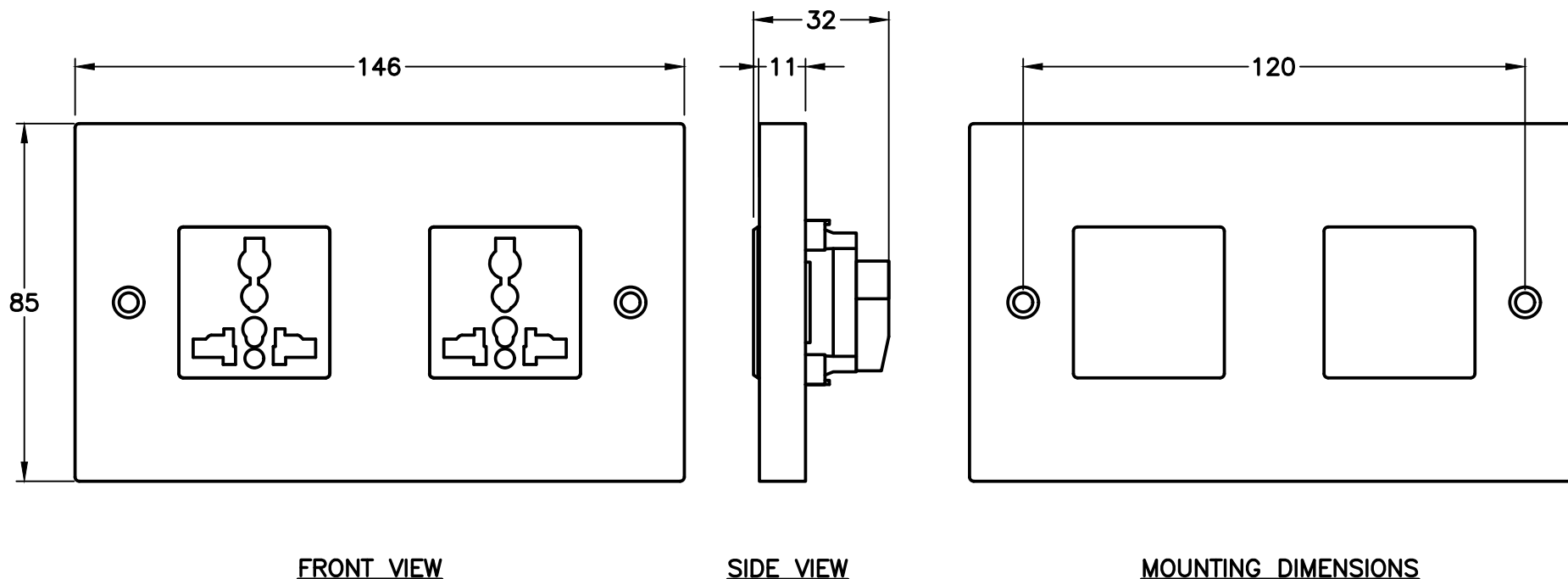

POWER STRIP OUTLETS (SOCKETS) ACCEPT MALE PLUG TYPES NOTED BELOW

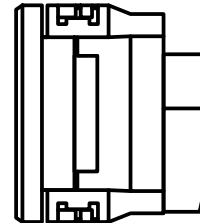
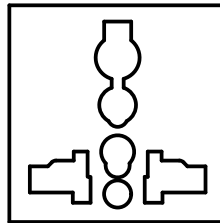











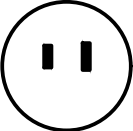
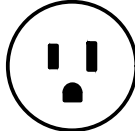
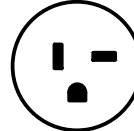
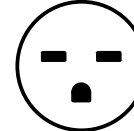
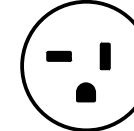
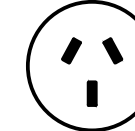
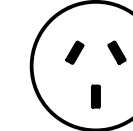
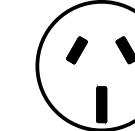



IMPORTANT:

THE "MAXIMUM" RATING OF 73556-UV-B IS 20 AMPERE 250 VOLT.

*POWER STRIP DOES NOT PROVIDE GROUNDED CONNECTION WHEN EU1-16P AND FR1-16P 3-WIRE GROUNDING PLUGS ARE USED.

USE 74900-SGA (SEE PAGE 3) OR 30140-BLK (SEE PAGE 4) TO ACHIEVE GROUNDED CONNECTION.

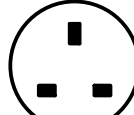
PLUG TYPES

 NEMA 1-15P / 15A-125V	 NEMA 5-15P / 15A-125V	 NEMA 5-20P / 20A-125V	 NEMA 6-15P / 15A-250V	 NEMA 6-20P / 20A-250V	 AR1-10P / 10A-250V	 AU1-10P / 10A-250V	 AU2-15P / 15A-250V	
 BR2-10P / 10A-250V	 BR3-10P / 20A-250V	 CH1-10P / 10A-250V	 DE1-13P / 16A-250V	 *EU1-16P / 16A-250V	 EUROPLUG / 4.0 MM PINS	 IS1-16P / 16A-250V	 IT1-10P / 10A-250V	
 SA1-16P / 16A-250V	 SW1-10P / 10A-250V	 TH1-16P / 16A-250V	 UK1-13P / 13A-250V	 UK3-5P / 5/6A-250V	<p>CONFIGURATION IDENTIFICATIONS</p> <p>AR = ARGENTINA AU = AUSTRALIA/NEW ZEALAND CH = CHINA DE = DENMARK EU = EUROPEAN "SCHUKO"/GERMANY EU/FR = FRANCE IS = ISRAEL IT = ITALY/CHILE</p>		<p>CONFIGURATION IDENTIFICATIONS</p> <p>NEMA = USA/CANADA/MEXICO SA = SOUTH AFRICA SW = SWITZERLAND TH = THAILAND UK = HONG KONG UK = SAUDI ARABIA/GULF STATES UK = S. AFRICA/INDIA UK = UNITED KINGDOM/IRELAND</p>	

CAT. No.

74900-SGA

ADD-ON ADAPTER FOR EUROPEAN, GERMAN, FRENCH CEE 7/7, 7/4 SCHUKO 16 AMPERE 250 VOLT PLUGS WHEN PLUGS ARE MATED WITH "UNIVERSAL" MULTI-CONFIGURATION POWER STRIPS, SOCKETS. ADD-ON ADAPTER PROVIDES "EARTH" GROUNDING CONNECTION.

NOTE:

- 1) CAUTION: FOR INSTALLATION AND USE BY QUALIFIED PERSONNEL ONLY.
- 2) INSTALL ADAPTER ON SCHUKO PLUG FIRST. ALIGN AND INSERT PLUG ADAPTER "GROUNDING EARTH PIN" INTO THE UNIVERSAL RECEPTACLE "GROUNDING" EARTH CONTACT ONLY AS INDICATED BELOW, STEPS 1, 2, 3.
- 3) SECONDARY OPTION: USE ADAPTER #30140-BLK IN PLACE OF 74900-SGA

PAGE 3 OF 4

ALL DIMENSIONS ARE IN MILLIMETERS

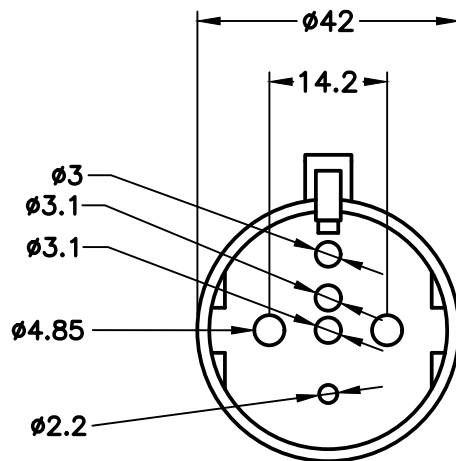
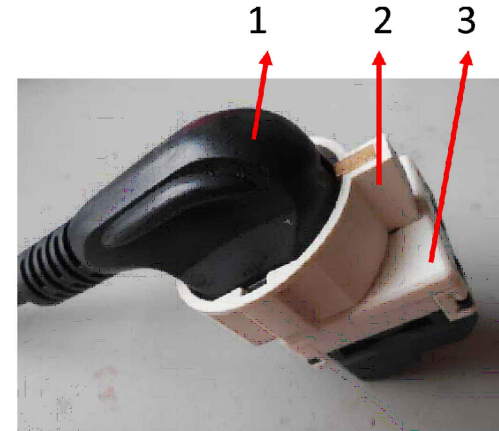
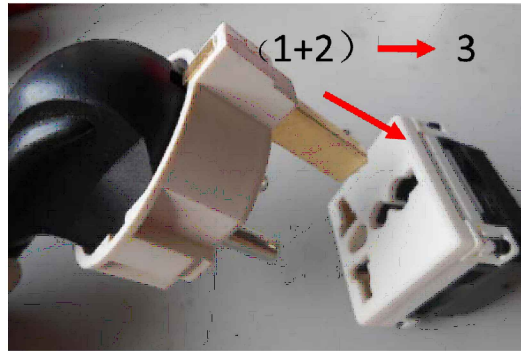
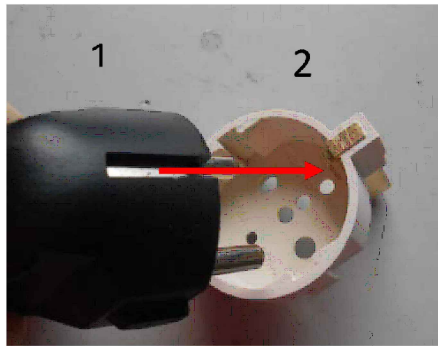

FRONT VIEW

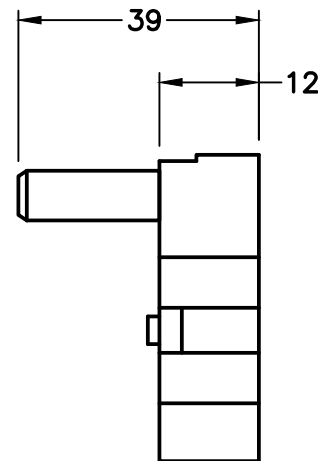

SIDE VIEW

CAT. No.

30140-BLK

BRITISH, UNITED KINGDOM 13 AMPERE 250 VOLT TYPE G PLUG ADAPTER. MATES SCHUKO, GERMAN, FRENCH, EUROPEAN CEE, CEE 7/4, CEE 7/7, CEE 7/16 (EU1-16P) PLUGS TO BRITISH BS 1363A (UK1-13R) POWER OUTLETS, 2 POLE-3 WIRE GROUNDING (2P+E), 13 AMPERE BS 1362 FUSE. BLACK.

CERTIFICATIONS

CE

STANDARDS

CEE 7/7 CEE 7/16 CEE 7/17 BS 1363A BS 1363 BS 1362 DIN 49440/49441

PAGE 4 OF 4

ALL DIMENSIONS ARE IN MILLIMETERS

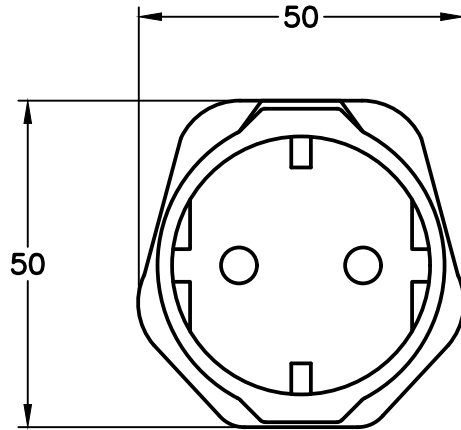

EU1-16P
FRONT VIEW

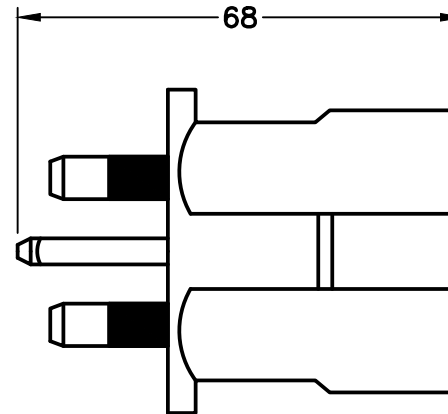

TOP VIEW

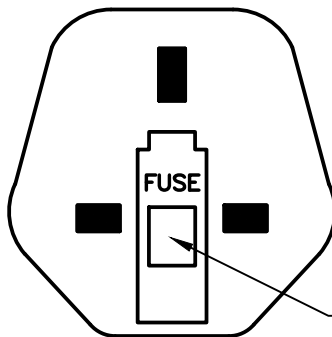

UK1-13P
BACK VIEW

CHANGEABLE
13 AMP FUSE

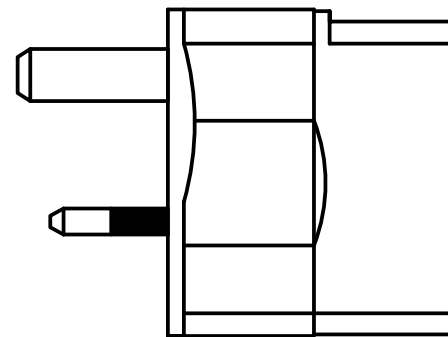

SIDE VIEW