

CAT. No.

73555-UV-W

UNIVERSAL 20 AMPERE 250 VOLT EUROPEAN, UK, BRITISH, DENMARK, SWISS, AUSTRALIA, CHINA, JAPAN, BRAZIL, ARGENTINA, AMERICA NEMA, SOUTH AMERICA, ASIA, THAILAND, ISRAEL, INTERNATIONAL, MULTI-CONFIGURATION OUTLET, BS 1363 TYPE G (UK1-13R), 86mmX86mm SIZE, SHUTTERED CONTACTS, 2 POLE-3 WIRE GROUNDING (2P+E). IVORY.

CERTIFICATIONS

ROHS CE

STANDARDS

EUROPEAN INTERNATIONAL TIS 166-2549

PAGE 1 OF 4

NOTES: OUTLET MOUNTS ON EUROPEAN, BRITISH WALL BOXES WITH 60mm (60.3mm) CENTERS.

ALL DIMENSIONS ARE IN MILLIMETERS

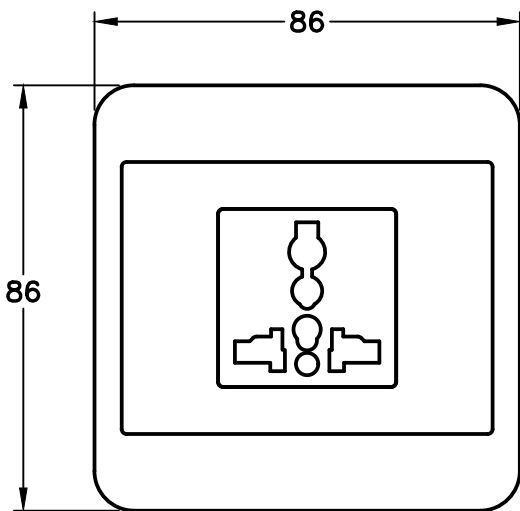

FRONT VIEW

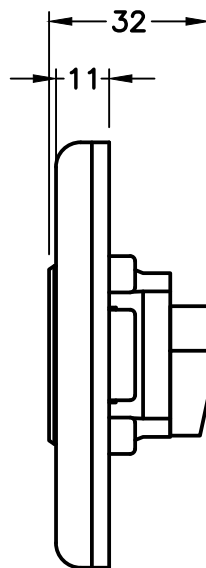

SIDE VIEW

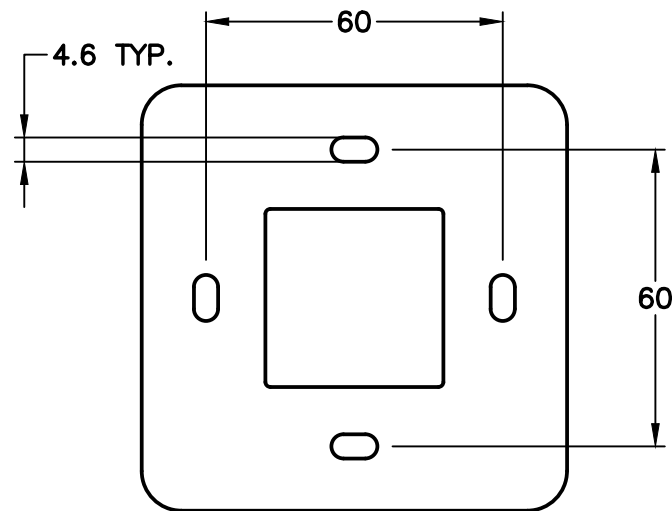

MOUNTING DIMENSIONS
(SHOWN WITHOUT COVER)

POWER STRIP OUTLETS (SOCKETS) ACCEPT MALE PLUG TYPES NOTED BELOW

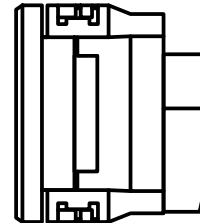
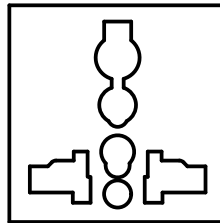









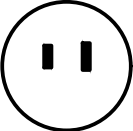
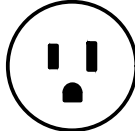
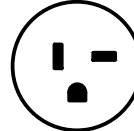
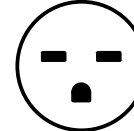
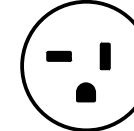
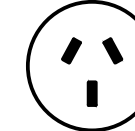
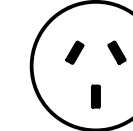
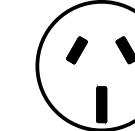
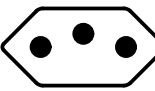
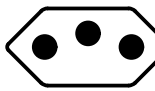

IMPORTANT:

THE "MAXIMUM" RATING OF 73555-UV-W IS 20 AMPERE 250 VOLT.

*POWER STRIP DOES NOT PROVIDE GROUNDED CONNECTION WHEN EU1-16P AND FR1-16P 3-WIRE GROUNDING PLUGS ARE USED.

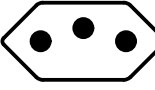
USE 74900-SGA (SEE PAGE 3) OR 30140-BLK (SEE PAGE 4) TO ACHIEVE GROUNDED CONNECTION.

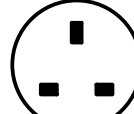
PLUG TYPES

 NEMA 1-15P / 15A-125V	 NEMA 5-15P / 15A-125V	 NEMA 5-20P / 20A-125V	 NEMA 6-15P / 15A-250V	 NEMA 6-20P / 20A-250V	 AR1-10P / 10A-250V	 AU1-10P / 10A-250V	 AU2-15P / 15A-250V	
 BR2-10P / 10A-250V	 BR3-10P / 20A-250V	 CH1-10P / 10A-250V	 DE1-13P / 16A-250V	 *EU1-16P / 16A-250V	 EUROPLUG / 4.0 MM PINS	 IS1-16P / 16A-250V	 IT1-10P / 10A-250V	
 SA1-16P / 16A-250V	 SW1-10P / 10A-250V	 TH1-16P / 16A-250V	 UK1-13P / 13A-250V	 UK3-5P / 5/6A-250V	<p>CONFIGURATION IDENTIFICATIONS</p> <p>AR = ARGENTINA AU = AUSTRALIA/NEW ZEALAND CH = CHINA DE = DENMARK EU = EUROPEAN "SCHUKO"/GERMANY EU/FR = FRANCE IS = ISRAEL IT = ITALY/CHILE</p>		<p>CONFIGURATION IDENTIFICATIONS</p> <p>NEMA = USA/CANADA/MEXICO SA = SOUTH AFRICA SW = SWITZERLAND TH = THAILAND UK = HONG KONG UK = SAUDI ARABIA/GULF STATES UK = S. AFRICA/INDIA UK = UNITED KINGDOM/IRELAND</p>	

CAT. No.

74900-SGA

ADD-ON ADAPTER FOR EUROPEAN, GERMAN, FRENCH CEE 7/7, 7/4 SCHUKO 16 AMPERE 250 VOLT PLUGS WHEN PLUGS ARE MATED WITH "UNIVERSAL" MULTI-CONFIGURATION POWER STRIPS, SOCKETS. ADD-ON ADAPTER PROVIDES "EARTH" GROUNDING CONNECTION.

NOTE:

- 1) CAUTION: FOR INSTALLATION AND USE BY QUALIFIED PERSONNEL ONLY.
- 2) INSTALL ADAPTER ON SCHUKO PLUG FIRST. ALIGN AND INSERT PLUG ADAPTER "GROUNDING EARTH PIN" INTO THE UNIVERSAL RECEPTACLE "GROUNDING" EARTH CONTACT ONLY AS INDICATED BELOW, STEPS 1, 2, 3.
- 3) SECONDARY OPTION: USE ADAPTER #30140-BLK IN PLACE OF 74900-SGA

PAGE 3 OF 4

ALL DIMENSIONS ARE IN MILLIMETERS

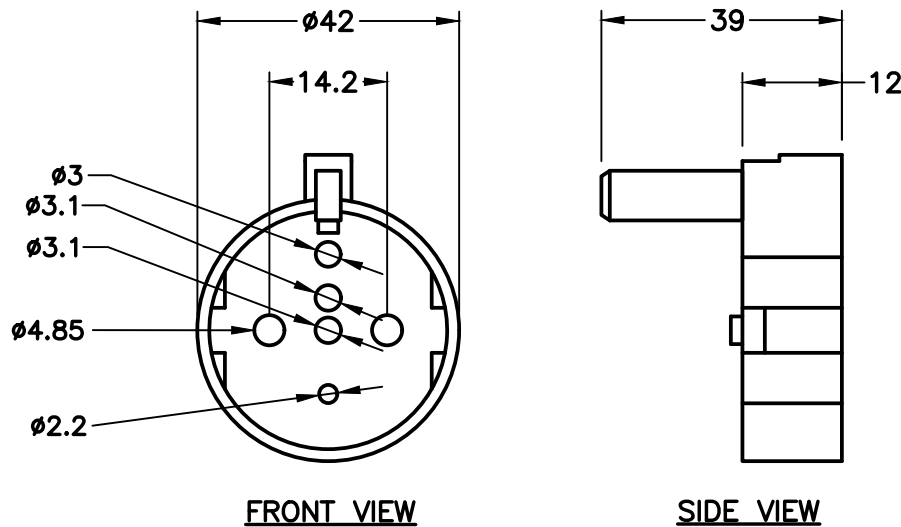
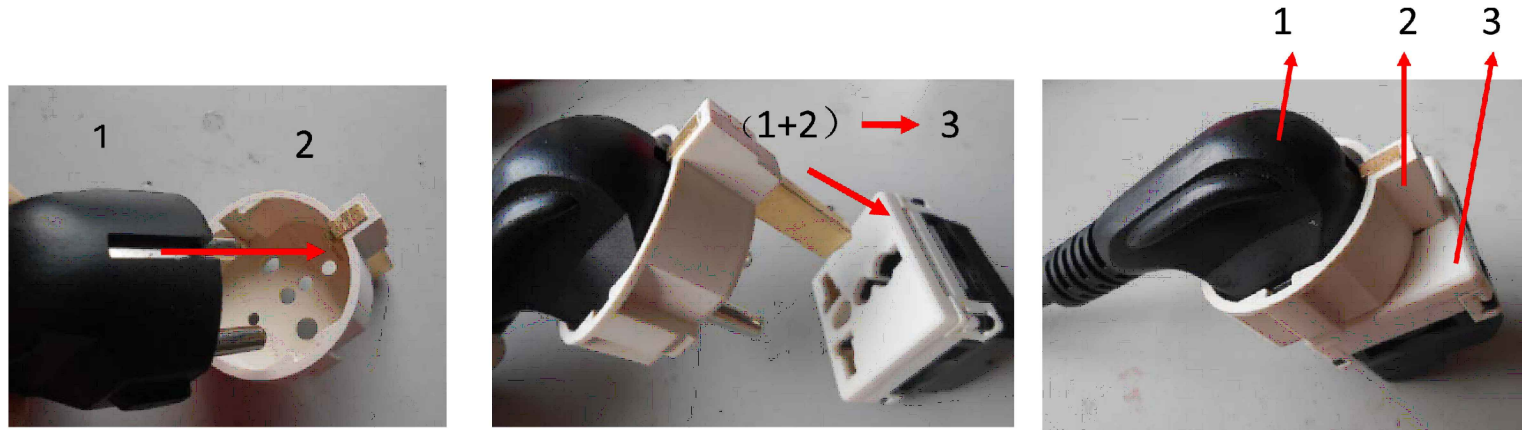

CAT. No.

30140-BLK

BRITISH, UNITED KINGDOM 13 AMPERE 250 VOLT TYPE G PLUG ADAPTER. MATES SCHUKO, GERMAN, FRENCH, EUROPEAN CEE, CEE 7/4, CEE 7/7, CEE 7/16 (EU1-16P) PLUGS TO BRITISH BS 1363A (UK1-13R) POWER OUTLETS, 2 POLE-3 WIRE GROUNDING (2P+E), 13 AMPERE BS 1362 FUSE. BLACK.

CERTIFICATIONS

CE

STANDARDS

CEE 7/7 CEE 7/16 CEE 7/17 BS 1363A BS 1363 BS 1362 DIN 49440/49441

PAGE 4 OF 4

ALL DIMENSIONS ARE IN MILLIMETERS

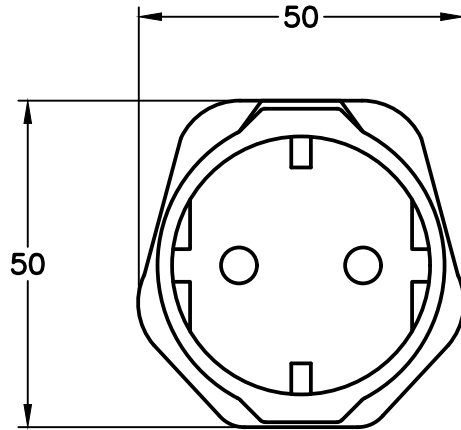

EU1-16P
FRONT VIEW

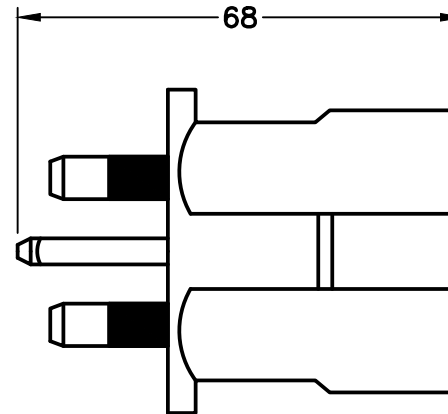

TOP VIEW

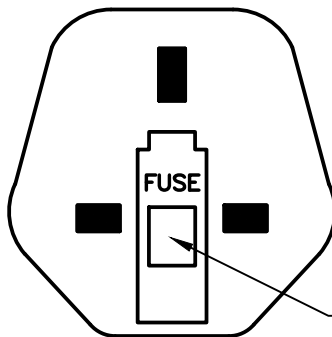

UK1-13P
BACK VIEW

CHANGEABLE
13 AMP FUSE

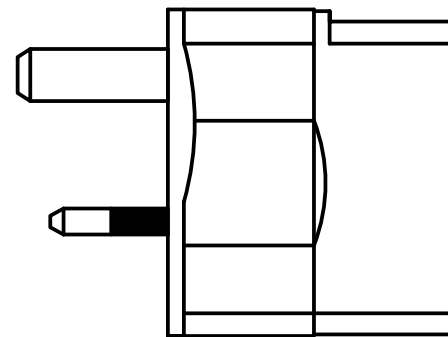

SIDE VIEW